

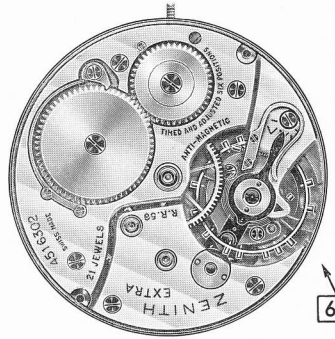

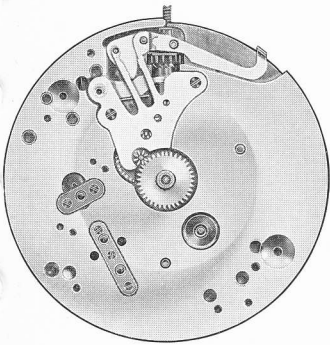

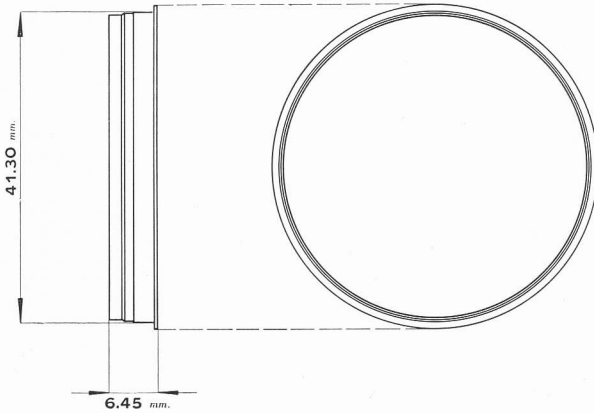





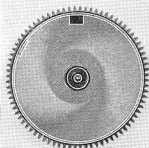



Calibre 69













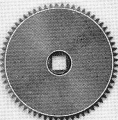

19" Ancre — 18,000 alternances











69

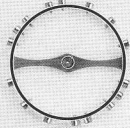
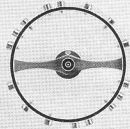

	■ 180	Barillet avec arbre
	■ 180/1	Barillet complet (avec ressort)
	■ 195	Arbre de barillet
	■ 200	Roue de centre avec chaussée <i>Indiquer hauteur de chaussée</i>
	■ 210	Roue moyenne
	■ 224	Roue de seconde, long pivot <i>Indiquer longueur du pivot dessous</i>
	■ 240	Chaussée lanternée <i>Indiquer hauteur</i>
	■ 250	Roue des heures <i>Indiquer hauteur de chaussée</i>
	■ 260	Roue de minuterie
	■ 302	Raquette pour spiral Breguet
	■ 311	Coqueret empierré
	■ 330	Plaque de contre-pivot empierrée pour balancier
	■ 334	Plaque de contre-pivot dessous pour roue d'ancre et ancre
	■ 336	Plaque de contre-pivot dessus pour roue d'ancre
	■ 349	Plaque de contre-pivot dessus pour ancre
	■ 357	Ressort-régulateur de raquette

	402	Tige négative (partie mouvement)
	407	Pignon coulant
	410	Pignon de remontoir
	414	Assise de roue de couronne
	415	Rochet
	420	Roue de couronne
	423	Noyau de roue de couronne
	425	Cliquet
	430	Ressort de cliquet
	435	Bascule
	440	Ressort de bascule
	444	Targette de mise à l'heure
	445	Ressort de tirette
	450	Renvoi et renvoi intermédiaire
	490	Bride de tige
	502	Axe de tirette

	702	Roue d'ancre pivotée, pour deux contre-pivots
	713	Ancre montée, pour deux contre-pivots
	719	Balancier sans axe (avec siette)
	720	Balancier pivoté avec plateau
	722	Balancier avec spiral Breguet
	■ 723	Axe de balancier
	■ 730	Plateau
	■ 735/1	Spiral Breguet réglé, piton triangulaire
	■ 770	Ressort de barillet

■	601/8	Chaton pour roue de centre dessus
■	602	Pierre de roue de centre dessous
■ ●	605/8	Chaton pour roue moyenne et pour roue de seconde dessus
■ ●	606	Pierre de roue moyenne et de roue de seconde dessous
	615/1	Pierre de roue d'ancre dessus, dessous et d'ancre dessus et dessous pour contre-pivot
	615/1/8	Chaton pour roue d'ancre dessus, pour contre-pivot
■ ●	630	Pierre de balancier dessus et dessous
	646	Palette d'entrée
	647	Palette de sortie
	648	Cheville de plateau
	717	Tige d'ancre pour deux contre-pivots
■	5101	Vis de fixation
■	5110	Vis de pont
■ ●	5125	Vis de pont d'ancre
	5311	Vis de coqueret
	5330	Vis de plaque de contre-pivot pour balancier
	5334	Vis de plaque de contre-pivot dessous pour roue d'ancre et ancre
	5336	Vis de plaque de contre-pivot dessus pour roue d'ancre
	5349	Vis de plaque de contre-pivot dessus pour ancre
■	5357	Vis de ressort régulateur de raquette (fixation)
■	5415	Vis de rochet
■	5420	Vis de roue de couronne
■ ●	5425	Vis de cliquet
■ ●	5430	Vis de ressort de cliquet
■ ●	5445	Vis de ressort de tirette
	5490	Vis de bride de tige (côté barillet)
	5490 A	Vis de bride de tige (côté tige de remontoir)
■	5739/1	Vis de piton
■ ●	5750	Vis de cadran

■ V. tableau de concordance

● V. tableau de concordance